

Product Page No.

Panel Information

Span-Line 36A Panel Profile..... PSP-2
 Panel Overview PSP-2

Flashing Profiles

Span-Line 36A Inside Corner PSP-3
 Span-Line 36A Outside Corner..... PSP-3
 1.5" Sill/Head PSP-3
 1.5" Sill to Soffit PSP-3
 1.25" Base PSP-3
 Span-Line 36A Jamb PSP-3
 Head Channel..... PSP-3
 Head Jamb Cover..... PSP-3

Accessory Profiles

Span-Line 36A Closures PSP-4
 Universal Closure PSP-4
 Tube Sealant PSP-4
 Tape Sealant..... PSP-4
 Touch-Up Paint..... PSP-4
 Continuous Ridge Vent..... PSP-4
 Louver with Screen..... PSP-4
 Panel Shear..... PSP-4

Testing Information

Section Properties and General Information PSP-5

Design/Installation Considerations

Fastener Installation Technique..... PSP-6
 Condition of Substructure..... PSP-6
 Fastening Information..... PSP-7

Detail Conditions

Span-Line 36A Outside Corner Detail PSP-8
 Span-Line 36A Inside Corner Detail PSP-8
 Span-Line 36A Jamb Detail..... PSP-9
 Head Detail..... PSP-9
 Base Detail PSP-10

Notes

Notes PSP-10-11

SPAN-LINE 36A PANEL OVERVIEW

SPAN-LINE 36A PROFILE

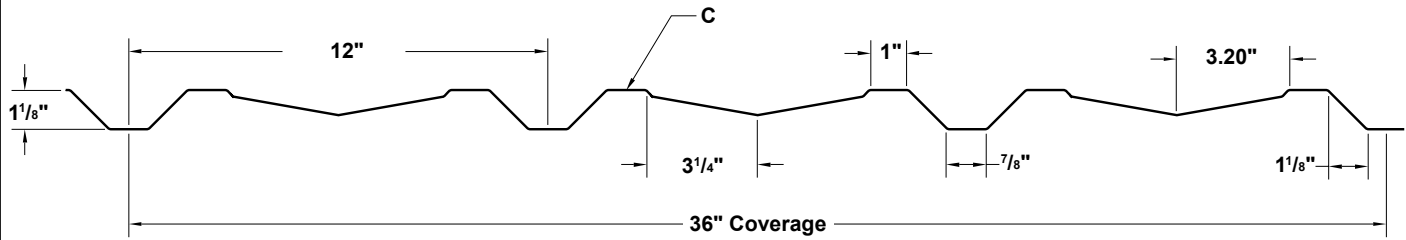

SLOPE

Span-Line 36A is designed for vertical applications and should not be used as a roofing panel.

SUBSTRATE

Span-Line 36A is designed to be utilized over open structural framing, but can easily be used with a solid substrate. The recommended substrate is $5/8$ " plywood with a 30 pound felt moisture barrier. To avoid panel distortion, use a properly aligned and uniform substructure.

COVERAGE

Span-Line 36A panels have a coverage of 36".

LENGTH

Lengths under 5'-0" are available with some cutting restrictions. Maximum recommended panel length is 45'-0". Longer panels require additional consideration in packaging, shipping, and erection. Please consult your Metal Sales branch for recommendations (see PGI-2 and PGI-3 for locations).

AVAILABILITY

Panels are available in 26, 24, and 22 gauge. Minimum quantity may apply.

APPLICATION

Commercial, Industrial, and Architectural panels.

FASTENING SYSTEM

Direct Fastened (exposed).

FASTENERS

The fastener selection guide should be consulted for choosing proper fasteners for specific applications. Quantity and type of fastener must meet necessary loading and code requirements (see PGI-12-14).

MATERIALS

Steel grade 50 per ASTM A-792
Steel grade 80 per ASTM A-792 or ASTM A-653

FINISH

- ▶ *Acrylic Coated Galvalume® (ACG) / ASTM A-792 - AZ55
- ▶ Prepainted Galvalume / ASTM A-792 - AZ50
- ▶ MS Colorfast45®
- ▶ **Fluorocarbon (PVDF)

* Differential appearance of Acrylic Coated Galvalume roofing materials is not a cause for rejection.

** Meets both Kynar 500 and Hylar 5000 specifications.

SPAN-LINE 36A FLASHING PROFILES

36A INSIDE CORNER

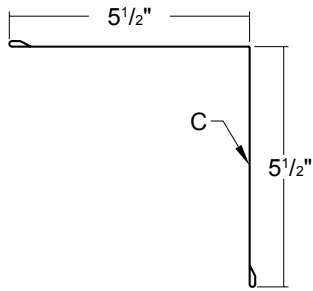

Length 10'-2", 20'-3"

36A OUTSIDE CORNER

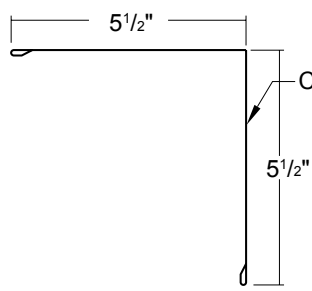

Length 10'-2", 20'-3"

1.5" SILL/HEAD

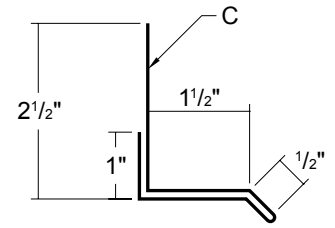

Length 10'-2"

1.5" SILL TO SOFFIT

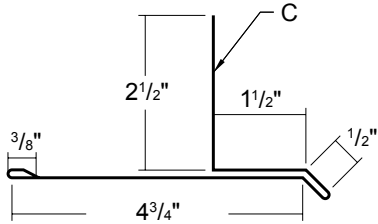

Length 10'-2"

1.25" BASE

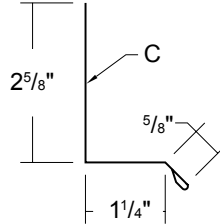

Length 10'-2"

SPAN-LINE 36A JAMB

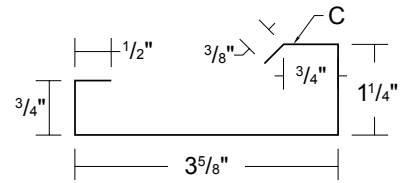

Length 10'-2"

HEAD CHANNEL

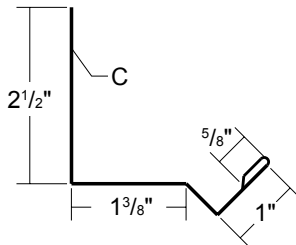

Length 10'-2"

HEAD JAMB COVER

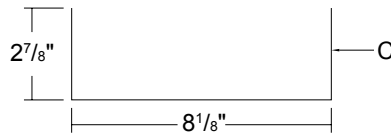

Length 10'-2", 14'-2"

**SPAN-LINE 36A
CLOSURES**



Outside Closure

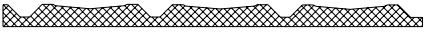

Inside Closure

Polyethylene Foam

UNIVERSAL CLOSURE

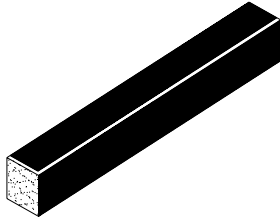

1" x 1 1/2" x 50' Polyethylene Foam
1" x 1 1/2" x 10' Polyethylene Foam

TUBE SEALANT

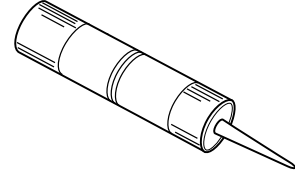

10.3 oz. Cartridge
Urethane

TAPE SEALANT

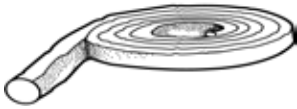

3/8" X 3/32" X 50'
Single Bead
Butyl - Gray

TOUCH-UP PAINT

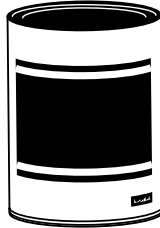

Available in pints
PVDF / MS Colorfast45

LOUVER WITH SCREEN

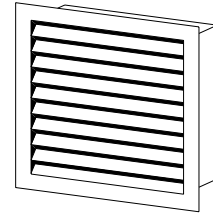

3' x 3', 3' x 4'

PANEL SHEAR

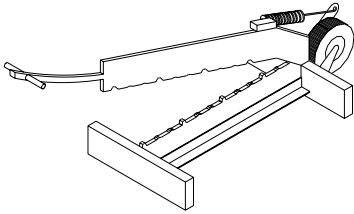

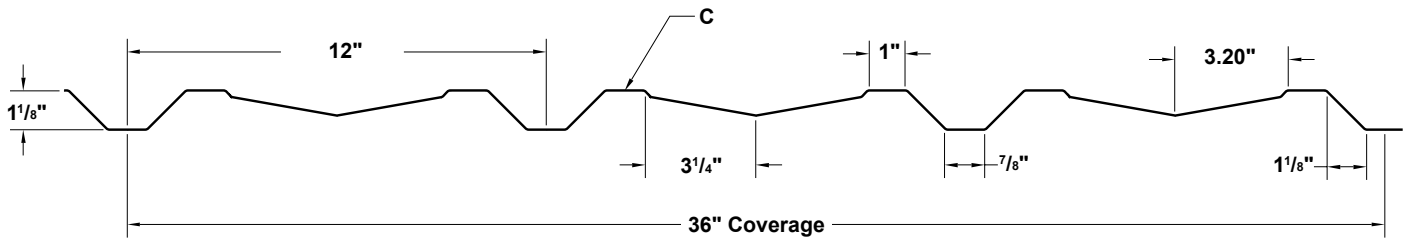

SECTION PROPERTIES								ALLOWABLE UNIFORM LIVE LOADS PSF (3 or More Equal Spans)											
Ga.	Width (in.)	Yield KSI	Weight PSF	Top in Compression		Bottom in Compression		Inward (Stress / Deflection) Load						Outward Uplift (Stress) Load					
				Ixx In ⁴ /ft	Sxx In ³ /ft	Ixx In ⁴ /ft	Sxx In ³ /ft	2'	3'	4'	5'	6'	7'	2'	3'	4'	5'	6'	7'
26	36"	80	0.88	0.0237	0.0290	0.0257	0.0341	206	99	57	37	26	19	242	114	66	42	30	22
24	36"	50	1.14	0.0353	0.0440	0.0363	0.0464	256	117	67	43	29	18	325	148	84	54	38	28
22	36"	50	1.47	0.0467	0.0586	0.0467	0.0607	306	147	85	55	38	24	397	189	109	71	50	37

- Theoretical section properties have been calculated per AISI 2001 "Specification for the Design of Cold-formed Steel Structural Members." Ixx and Sxx are effective section properties for deflection and bending.
- Allowable load is calculated in accordance with AISI 2001 specifications considering bending, shear, combined bending and shear, deflection, and applicable testing when available. Allowable load considers the worst case of 3 and 4 equal span conditions. Allowable load does not address web crippling or fasteners/support connection and panel weight is not considered.
- Deflection consideration is limited by a maximum deflection ratio of L/180 of span.
- Allowable loads do not include a 1/3 stress increase in uplift.

ATTACHMENT DETAIL

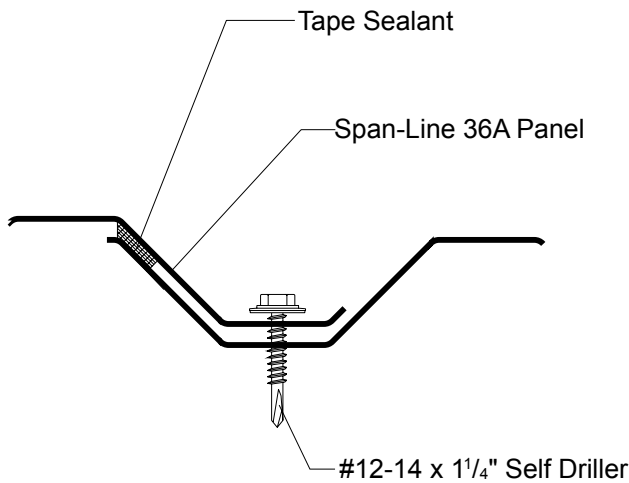

FASTENING PATTERN

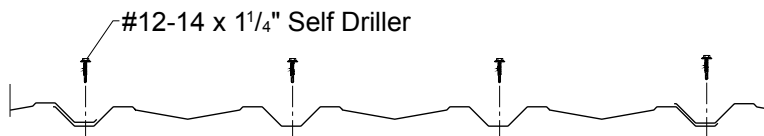

GENERAL INFORMATION

- Substructure**
 Span-Line 36A is designed to be utilized over open structural framing but can easily be used with a solid sub-structure. To avoid panel distortion use a properly aligned and uniform substructure.
- Coverage**
 Span-Line 36A panels are available in a 1 1/8" rib height with a coverage width of 36".
- Length**
 Minimum factory cut length is 5'-0". Maximum recommended panel length is 45'-0". Longer panels require additional consideration in packaging, shipping, and erection. Please consult Metal Sales for recommendations.
- Fasteners**
 The fastener selection guide should be consulted for choosing the proper fastener for specific applications. Quantity and type of fastener must meet necessary loading and code requirements.
NOTE: All panels are subject to surface distortion due to improperly applied fasteners. Overdriven fasteners will cause stress and induce oil canning across the face of the panel at or near the point of attachment.
- Availability**
Finishes: Acrylic Coated Galvalume®, MS Colorfast45®, or various Kynar 500 (PVDF) colors.
Gauges: 26 ga and 24 ga standard, 22 ga optional

FASTENER INSTALLATION TECHNIQUE

Recommended Tool Type - Use depth locating nose or adjustable clutch on screw gun to prevent overdrilling and strip out. **Do not use impact tools or runners.**

Seating the washer - Apply sufficient torque to seat the washer - do not overdrive the fastener.

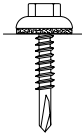
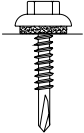
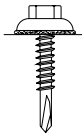
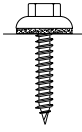
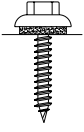
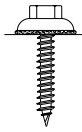
	CORRECT Sealing material slightly visible at edge of metal washer. Assembly is watertight.	TOO LOOSE Sealing material is not visible; not enough compression to seal properly.	TOO TIGHT Metal washer deformed; sealing material pressed beyond washer edge.
SELF DRILLER			
WOODSCREW			

To prevent wobbling - Make sure fastener head is completely engaged in the socket. If the head does not go all the way in the socket - tap the magnet deeper into the socket to allow full head engagement. Metal chips will build up from drilling and should be removed from time to time.

Protect drill point - Push only hard enough on the screw gun to engage clutch. This prevents excess friction and burn out of the drill point. Correct pressure will allow screw to drill and tap without binding.

Drilling through sheet and insulation - Ease up on pressure when drilling through insulation to avoid striking the purlin or girt with the point - apply more pressure after drill point contacts purlin or girt.

Drilling through purlin overlaps - Drilling through lapped purlins requires extra care. Excessive voids between purlins sometimes damages drill points and two self-drillers might be necessary to complete the operation. It is sometimes advantageous to predrill.

CONDITION OF SUBSTRUCTURE

Whether over solid substrate or open structural framing, panel distortion may occur if not applied over properly aligned and uniform substructure.

The installer should check the roof deck for squareness before installing Span-Line Panels. Several methods can be used to verify squareness of the structure for proper installation of the panels.

METHOD "A" - One method for checking the roof for squareness is to measure diagonally across one slope of the roof from similar points at the ridge and eave and obtain the same dimension.

METHOD "B" - The 3-4-5 triangle system may also be used. To use this system measure a point from the corner along the edge of the roof at a module of three (3). Measure a point from the same corner along another edge at a module of four (4). Then by measuring diagonally between the two points established, the dimension should be exactly a module of five (5) to have a square corner. Multiple uses of this system may be required to determine building squareness. If the endwall cannot be made square, the roof system cannot be installed as shown in these instructions.

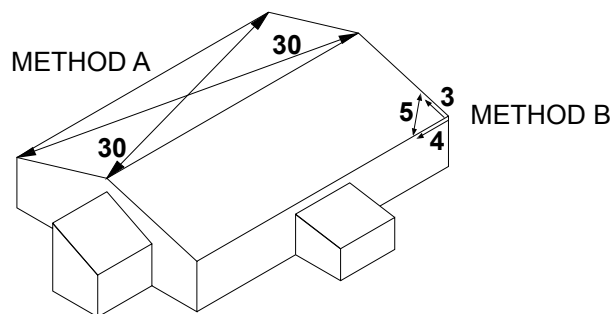

SPAN-LINE 36A FASTENING PATTERN

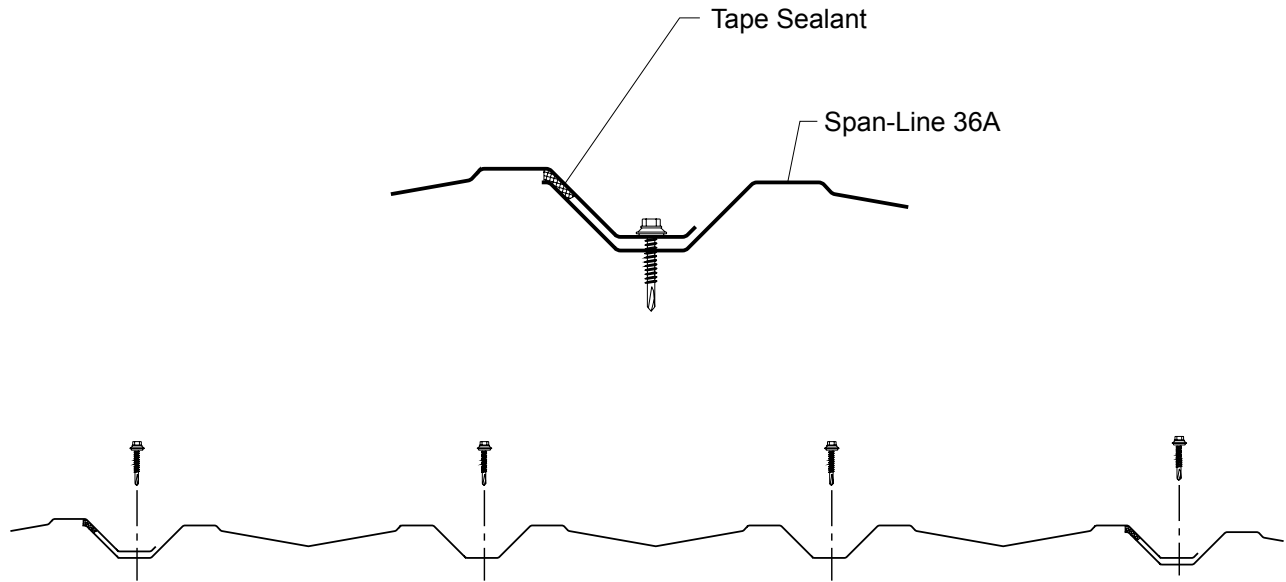

Span-Line 36A Fastening Pattern

SPAN-LINE 36A OUTSIDE CORNER DETAIL

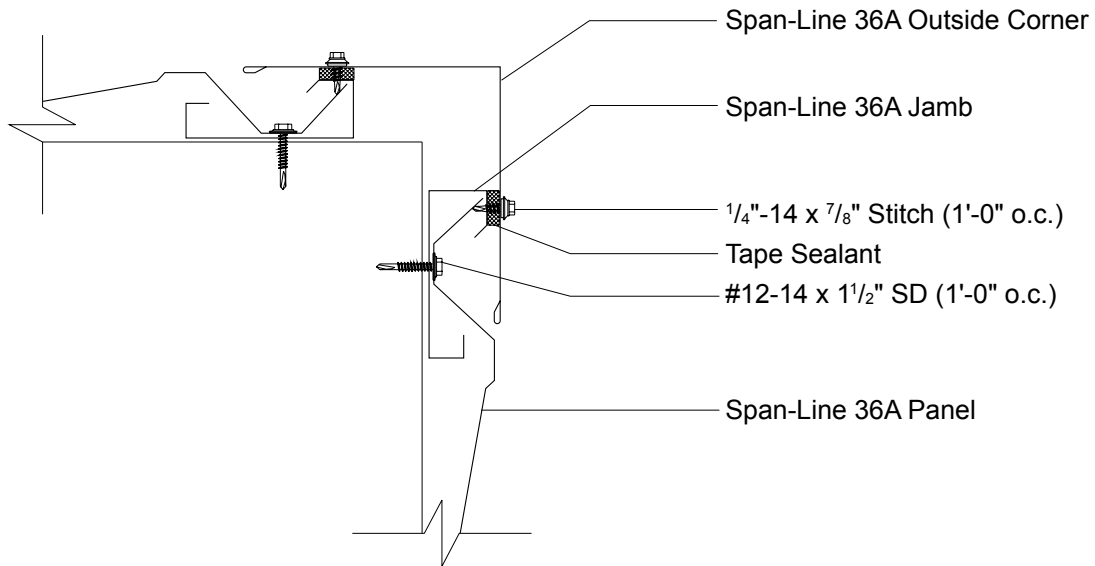

SPAN-LINE 36A INSIDE CORNER DETAIL

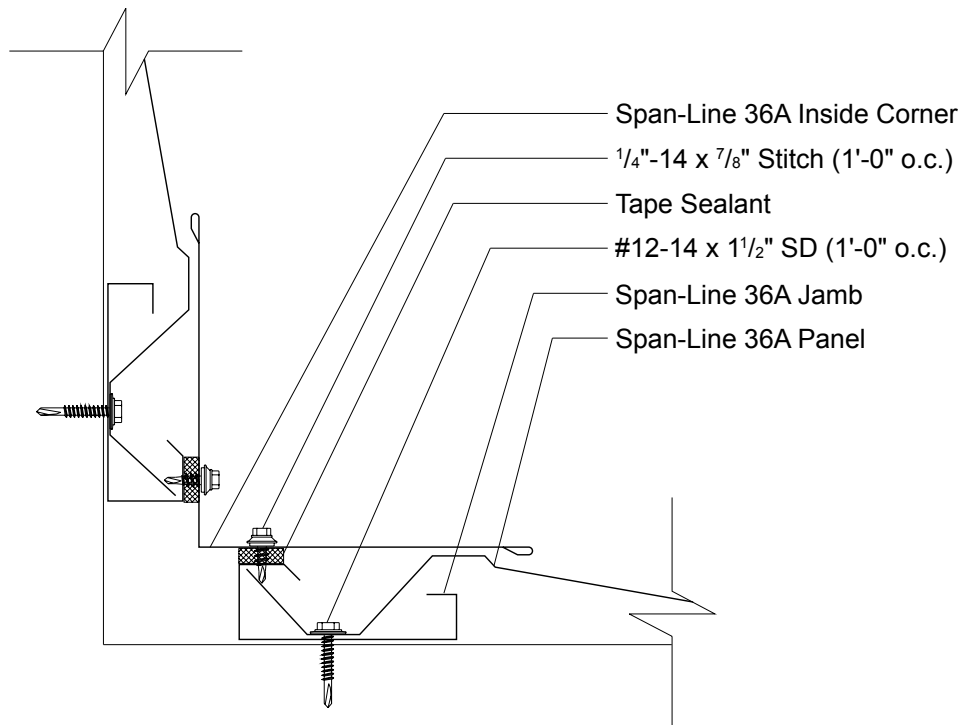

SPAN-LINE 36A JAMB DETAIL

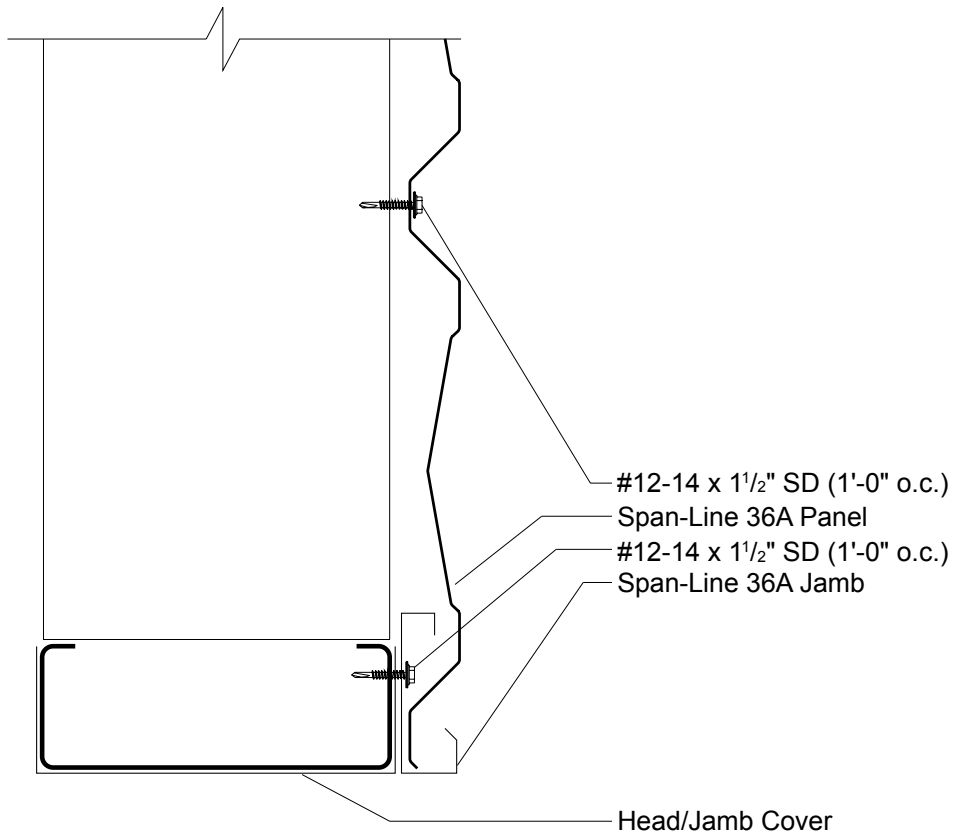

SPAN-LINE 36A HEAD DETAIL

